

Medium Access Control Protocols Using Directional Antennas in Ad Hoc Networks

Young-Bae Ko, Vinaychandra Shankarkumar, and Nitin H. Vaidya

Department of Computer Science

Texas A&M University

College Station, TX 77843-3112, USA

youngbae,v0s5080,vaidya@cs.tamu.edu

Abstract—Using directional antennas can be beneficial for wireless ad hoc networks consisting of a collection of wireless hosts. To best utilize directional antennas, a suitable Medium Access Control (MAC) protocol must be designed. Current MAC protocols, such as the IEEE 802.11 standard, do not benefit when using directional antennas, because these protocols have been designed for omnidirectional antennas. In this paper, we attempt to design new MAC protocols suitable for ad hoc networks based on directional antennas.

Keywords—MAC protocols, Directional Antennas, Ad Hoc Networks.

I. INTRODUCTION

A wireless, mobile ad hoc network is an autonomous system of mobile nodes which are typically assumed to be equipped with *omnidirectional antennas*¹ [5]. However, it is also possible to use *directional antennas* [7] or *adaptive antennas* [12] to improve the ad hoc network capacity. Using directional antennas may offer several interesting advantages for ad hoc networks. For instance, routing performance could be improved by using a directional antenna (for route discovery [10] or for data delivery).

To best utilize directional antennas, a suitable medium access control (MAC) protocol must be used. Current MAC protocols, such as the IEEE 802.11 standard [2], do not benefit when using directional antennas, because these protocols have been designed to exploit omnidirectional antennas. In this paper, we propose new MAC protocols using directional antennas.

Physical size limitations may prohibit the use of directional antennas on handheld devices. However, it is practical to use them on vehicle-mounted devices. Also, use of higher frequency bands reduces the physical size of directional antennas.

II. RELATED WORK

Although work on MAC protocols for directional antennas has been limited, some researchers have previously suggested use of directional antennas for packet radio networks. For example, Zander [20] has proposed the use of directional antennas in slotted ALOHA multihop packet radio networks whose broadcast radio channel is shared by means of the random time division multiple access (RTDMA) scheme. More recently, a way of using adaptive directional antennas for Mobile Broadband Systems (MBS) has been proposed [7]. In [7], the authors argue that conventional MAC protocols are not suitable for directional antennas and suggest a dynamic slot assignment (DSA) protocol

for directional antennas. Other researchers have also suggested using directional antennas for packet radio networks [11], [13], [19].

Recently, use of adaptive antennas has been considered in packet-switched systems. For example, [17] and [18] showed that using adaptive antennas can make the performance of a slotted ALOHA packet radio networks to improve. In their study, the adaptive antenna basestation is allowed to receive multiple packets simultaneously, resulting in the performance improvement. This ability of multiple reception at the same time is known as “space division multiple access (SDMA).” SDMA has been treated as a technology to increase the capacity of cellular mobile communication systems and has lately been studied in [14], [15]. Especially, in [14], a CSMA/SDMA protocol has been presented to mitigate the effects of hidden terminal problems.

The hidden terminal problem arises due to the possibility that transmissions from two nodes which cannot hear each other, may interfere at a third node. Unfortunately, many packet radio network environments suffer from packet corruption due to this problem. While modern MAC protocols for omnidirectional antennas have taken this problem into account [4], [8], [16], it is not adequately considered in previous studies of using directional antennas in packet radio networks.

III. PRELIMINARIES

A. Network Model

We assume that all hosts in a region share a wireless channel and communicate on that shared channel. Each host is assumed to be equipped with multiple directional antennas. A directional antenna can transmit over a small angle (e.g., 90 degrees), and several directional antennas may be used together to cover all directions².

We assume that transmissions by two different nodes will interfere at some node X, even if different directional antennas at node X receive these two transmissions. This assumption is somewhat pessimistic, and removing this assumption will improve the performance of the proposed protocols. This assumption is justified, for instance, in the case where signals received by all antennas are combined before sending to the receiving circuitry. We also assume that simultaneous transmissions by the same node to different directions are not allowed.

This research is supported in part by National Science Foundation grants ANI-9976626, ANI-9973152 and 9972235.

¹An omnidirectional antenna transmits in all directions (i.e., 360 degrees).

²Alternatively, an omnidirectional antenna may be used.

Each host has a fixed transmission range and two hosts are said to be neighbors if they can communicate with each other over a wireless link. Initially, we assume that each node knows its neighbors' location as well as its own location. At the end of this paper, we briefly consider the case when location information is not known accurately. The physical location information may be obtained using the global positioning system (GPS) [1]. Based on location of the receiver, the sender may select an appropriate directional antenna to send packets to the receiver.

Most of the current MAC protocols, such as IEEE 802.11 MAC standard [2], use a handshake mechanism implemented by exchanging small control packets named *Request-to-Send (RTS)* and *Clear-to-Send (CTS)*. The successful exchange of these two control packets reserves the channel for transmission of the, potentially longer, data packet and a short acknowledgement (ACK) packet.

B. RTS/CTS Mechanism in IEEE 802.11 MAC Protocol

Figure 1 illustrates the IEEE 802.11 MAC protocol [2] for omnidirectional antennas that uses RTS and CTS messages. In this protocol, any node that wishes to transmit data must send a RTS packet before it can start data transmission. For example, in Figure 1, node B broadcasts a RTS packet for its intended receiver, node C. (Please see caption of Figure 1 for an explanation of the figure). If C receives the RTS successfully, it replies with a CTS packet so that B can start transmitting a data packet upon receiving the CTS. When node C successfully receives the data packet, it immediately sends an ACK to node B (the ACK has a priority over any other transmission by any node in the vicinity of nodes B and C). Note that both RTS and CTS packets contain the proposed duration of data transmission. Since nodes are assumed to transmit using omnidirectional antennas, all nodes within the radio range of B and C will hear one or both of those control packets (nodes A and D in Figure 1) – these nodes must wait for the duration of data transmission before they can transmit themselves. Thus, the area covered by the transmission range of both the sender (node B) and the receiver (node C) is reserved for the data transfer from B to C, to prevent collisions. This characteristic of RTS/CTS mechanism overcomes the hidden terminal problems in wireless LAN environments. However, it is easy to see that this mechanism can waste a large portion of the network capacity by reserving the wireless medium over a large area. For instance, even though node D has data packets for node E while B and C are communicating with each other, node D has to defer the transmission to E until the transmission from node B to C is completed.

IV. DIRECTIONAL MAC (D-MAC) SCHEMES

The proposed Directional MAC (D-MAC) schemes are similar to IEEE 802.11 in many ways. The directional MAC schemes also send an ACK immediately after the DATA, as in 802.11 – however, in D-MAC schemes, the ACKs are sent using a directional antenna, instead of an omnidirectional antenna. In 802.11, if a node X is aware of an on-going transmission between some other two nodes (due to the receipt of an RTS or CTS from those nodes), node X will not participate in a transfer itself – that is, X will not send an RTS, or send reply to an RTS from another node, while the transfer between other two nodes

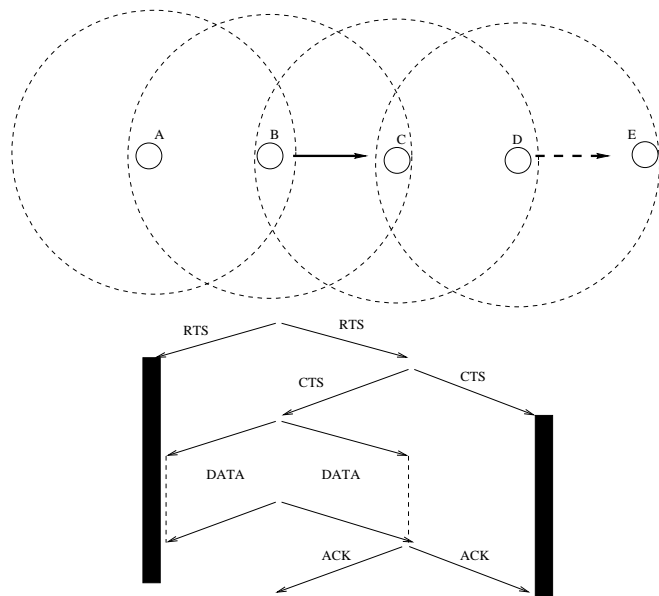

Fig. 1. MAC protocol with omnidirectional RTS/CTS mechanism: The circle centered at each node shows its transmission range. In the lower half of the figure, time progresses from top to bottom. The figure shows messages sent by various nodes. Black bars below nodes A and D indicate that these nodes are not allowed to transmit in the duration covered by the bars (to avoid interference with the transfer from B to C).

is in progress. The directional MAC protocols apply a similar logic, but on a per-antenna basis. In brief, if antenna T at node X has received an RTS or CTS related to an on-going transfer between two other nodes, then node X will not transmit anything using antenna T until that other transfer is completed. Antenna T would be said to be “blocked” for the duration of that transfer – the duration of transfer is included in each RTS and CTS packet (as in IEEE 802.11), therefore, each node can determine when a blocked antenna should become unblocked.

The key point to note above is that, when using directional antennas, while one directional antenna at some node may be blocked (as defined above), other directional antennas at the same node may not be blocked, allowing transmission using the unblocked antennas. This property results in performance improvement when using directional antennas.

Omnidirectional transmission of a packet in D-MAC schemes requires the use of all the directional antennas. Therefore, an omnidirectional transmission can be performed if and only if none of the directional antennas are blocked.

A. Scheme 1: Using DRTS packets

Directional MAC (D-MAC) scheme 1 utilizes a directional antenna for sending the RTS packets in a particular direction, whereas CTS packets are transmitted in all directions. Figure 2 and Figure 3 show how wireless bandwidth efficiency of the 802.11 MAC protocol can be improved by using a directional MAC protocol. In Figure 2, assume that node B has a data packet for node C, and also assume that no other data transfers are in progress (so none of the antennas are blocked). In this case, node B sends a *directional RTS (DRTS)* packet including the physical location information of B, in the direction of node C. Thus, node A does not receive the DRTS from node B

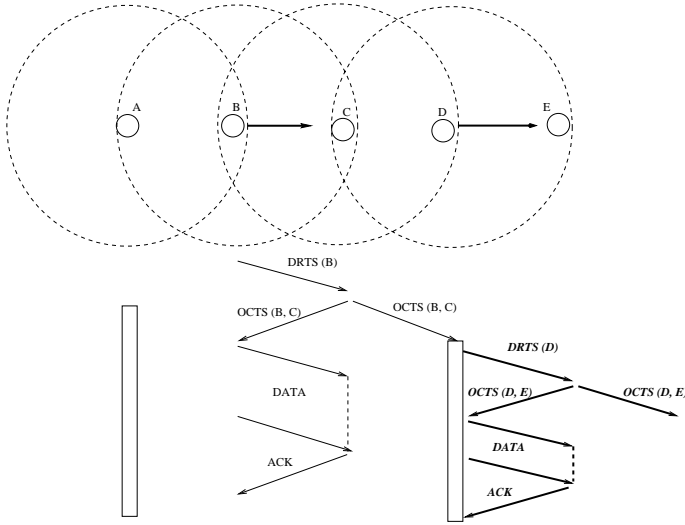

Fig. 2. Example of using a Directional MAC Scheme 1: This figure uses notation similar to Figure 1. Letters in parentheses, such as $DRTS(B)$ or $OCTS(B,C)$, denote the physical location information included in the message. The white box below node D denotes that node D may transmit to node E in the corresponding duration, unlike when using omnidirectional antennas.

even though node A also exists within B's transmission range. If node C receives the DRTS packet from B successfully, it then returns an *omnidirectional CTS (OCTS)* reply. Two location informations are included in the OCTS packet: location of the node sending OCTS (node C's location in Figure 2) and location of the sender of the corresponding DRTS packet (node B in Figure 2). After the successful exchange of DRTS and OCTS packets, a data packet is sent by node B using a directional antenna. When node C receives the data packet, it immediately sends an ACK to node B using a directional antenna.

Now, during the proposed length of transmission between B and C, assume that node D, which is a neighbor of node C, has data to transmit to node E. Note that the directional antenna of node D that points towards node C is *blocked*, since node D would have received on this directional antenna the OCTS sent by node C to node B. However, the blocked antenna is different from the directional antenna that points towards node E. Therefore, node D can send a directional RTS packet towards node E. Essentially, if node D knows that its data transmission to node E would not interfere with the other on-going data transfer from B to C, D sends a DRTS control packet to E. As a result, our modified MAC protocol for directional antennas can improve performance by allowing simultaneous transmissions that are disallowed when using only omnidirectional antennas.

Similarly, in Figure 3, node A is allowed to transmit to node F while transmission between B and C is taking place. This is possible because node A does not receive the DRTS from node B, so node A is not blocked from transmitting the DRTS to node F. Note that, with standard omnidirectional RTS/CTS mechanisms, node A in Figure 3 must defer transmission to node F until the transmission from B to C finishes, causing performance degradation.

Let us now consider some other node X in Figure 3 whose location is covered by the directional antenna of B pointing to-

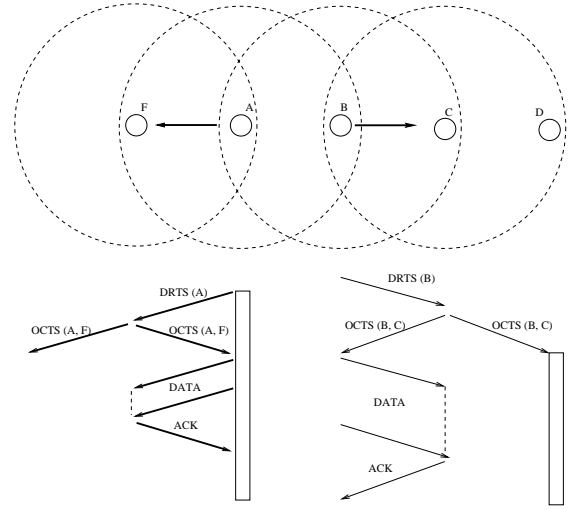

Fig. 3. Another Example of using Directional MAC Scheme 1

wards node C. Clearly, node X will also receive the DRTS from B when node B sends the DRTS packet to node C, as shown in Figure 4(a) and (b). Therefore, the directional antenna at node X that points towards node B will be blocked for the duration of transfer from B to C. With this scenario, in scheme 1, node X is still allowed to initiate its data transmission to some other node Y as long as the directional antenna at node X that points towards Y is *not blocked* by the receipt for DRTS from node B (or, by the receipt of DRTS or OCTS from some other node).

When a node Y gets a DRTS packet from node X, Y may or may not send an OCTS to X, depending on the status of its directional antennas. Since an omnidirectional CTS (OCTS) packet transmission requires the use of all directional antennas, an OCTS cannot be sent if any of the directional antennas are blocked. Therefore, node Y transmits an OCTS in reply to the DRTS from node X if and only if none of its directional antennas are blocked. Thus, in Figure 4(a), node Y may send an OCTS to node X, however in Figure 4(b), node Y may not send the OCTS. Since, in case (b) of Figure 4, node Y would have received an OCTS from node C blocking its directional antenna for the duration of transfer from B to C.

The appendix briefly presents pseudo-code for our D-MAC scheme 1.

B. Scheme 2: Using both DRTS and ORTS packets

In our first directional MAC protocol to improve network performance, a directional RTS (DRTS) packet is transmitted in the direction of the intended receiver prior to the transmission of the actual data packets – D-MAC scheme 1 does not use omnidirectional RTS (ORTS) packets. Using DRTS, instead of omnidirectional RTS, may increase the probability of control packet collisions in some cases. We consider one such scenario in Figure 5. In Figure 5, assume that node B has initiated a packet transfer to node C. Node A is unaware of this transfer, since node B's DRTS to node C has not received by node A. Now, node A wants to send a packet to node B, while B's transfer to node C is still in progress. Transmission of a DRTS by node A to node B may interfere with the reception of OCTS or ACK control packets sent

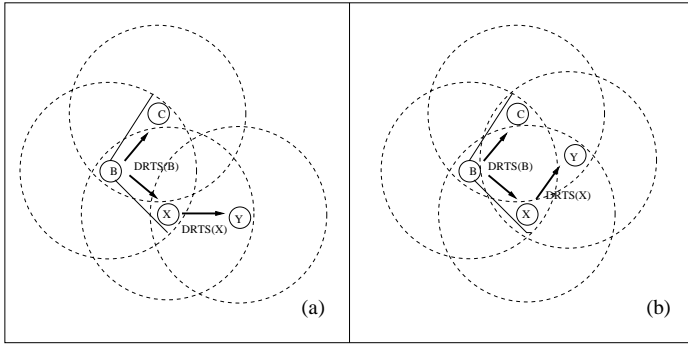

Fig. 4. A different way to react when node receives DRTS: In the figures, on receiving an DRTS from node X, node Y may or may not reply the corresponding OCTS towards X, based on the status of node Y's directional antennas.

by node C to node B³. Note that node A does not defer its attempt to communicate with node B because A has not received node B's DRTS packet directed to node C. This situation cannot happen in the current omnidirectional RTS/CTS exchange mechanisms. Since the size of control packets is typically much smaller than the data packets, the probability of collisions described above is not very high, although it is higher than that in case of IEEE 802.11 MAC.

To reduce the probability of collisions between control packets, we propose directional MAC scheme 2. In D-MAC scheme 2, there are two types of RTS packets: *directional RTS (DRTS)* and *omnidirectional RTS (ORTS)*.

In scheme 2, when a node, say node X, wishes to initiate a data transfer, it may send ORTS or DRTS as per two rules: (a) if none of the directional antennas at node X are blocked, then node X will send an omnidirectional RTS (ORTS). (b) otherwise, node X will send a directional RTS (DRTS) provided that the desired directional antenna is not blocked. If the desired antenna is blocked, node X will defer until that antenna becomes unblocked.

For example, in Figure 5, assume that when node B wants to send a packet to node C, none of the antennas at B are blocked. In this case, node B will broadcast an ORTS packet (as per rule (a) above). Since this packet will be received by node A, its directional antenna pointing towards B will be blocked for the duration of the transfer from B to C. Now consider two cases:

- If node A wants to send data to node B, it will wait for the duration of transfer from B to C (until the corresponding directional antenna becomes unblocked, as per rule (b) above).
- If node A wants to send data to node F, node A will send a DRTS to node F, provided that the directional antenna pointing towards node F is not blocked (as per rule (b) above).

The combination of DRTS and ORTS packets in scheme 2 can reduce the cases of collisions between control packets (although it does not eliminate the possibility). Apart from the two rules mentioned above which determine if a node will send ORTS or

³Recall that we make the pessimistic assumption that signals received on different directional antennas at a given node can interfere. If this assumption is not true, then scheme 2 is not needed, and performance of scheme 1 would be better than reported here. However, when the receiver hardware is constrained, our pessimistic assumption may also be true.

DRTS, our D-MAC scheme 2 is identical to scheme 1.

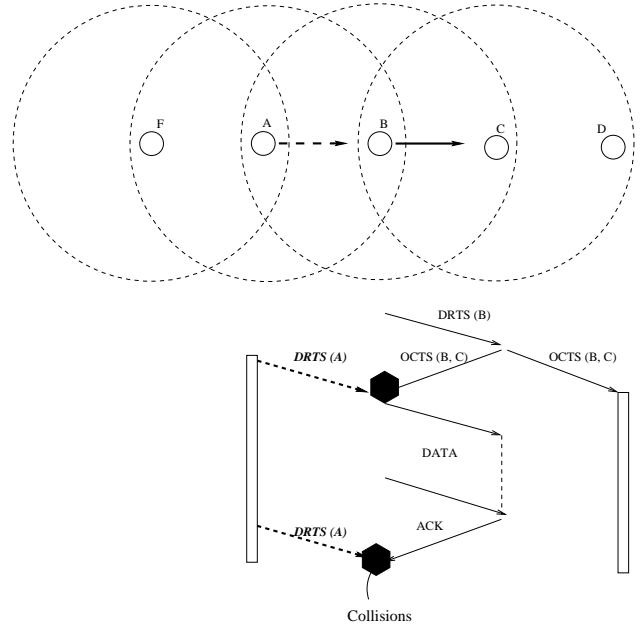

Fig. 5. A possible scenario of collisions with DRTS packets

V. PERFORMANCE EVALUATION

To evaluate our protocols, we performed simulations using an extended version of the UCB/LBNL network simulator, *ns-2* [3], [6]. The *ns-2* simulator is a discrete event network simulator that was developed as part of VINT project at the Lawrence Berkeley National Laboratory. The extensions implemented by the CMU Monarch project - which enable it to accurately simulate mobile nodes connected by wireless network interfaces and multi-hop wireless ad hoc networks - were used. We modified the *ns-2* to implement the directional antennas which could transmit in a particular direction (90 degrees). In our modification, location information was incorporated into the wireless transmissions.

A. Simulation Model

We consider the 5x5 mesh topology illustrated in Figure 6. The nodes form 5 rows and 5 columns, with two adjacent rows and two adjacent columns being separated by 200 meters. We briefly evaluate the case of 3x3 and 6x6 mesh topologies at the end of the next subsection. Transmission range of each node is 250 meters and the wireless link bandwidth is 2 Mbps. TCP-Reno is used for the transport layer over the IEEE 802.11 MAC layer. The traffic model used in our simulation is FTP with infinite backlog at each source node. The TCP packet size is 1460 bytes and the maximum advertised window is 8 packets.

Each simulation is performed for a duration of 900 seconds. Each performance measurement reported below is averaged over 20 executions.

B. Simulation Results

The performance metric used to evaluate the protocols is TCP throughput. The unit for all throughput measurements reported here is Kilobits/second (Kbps).

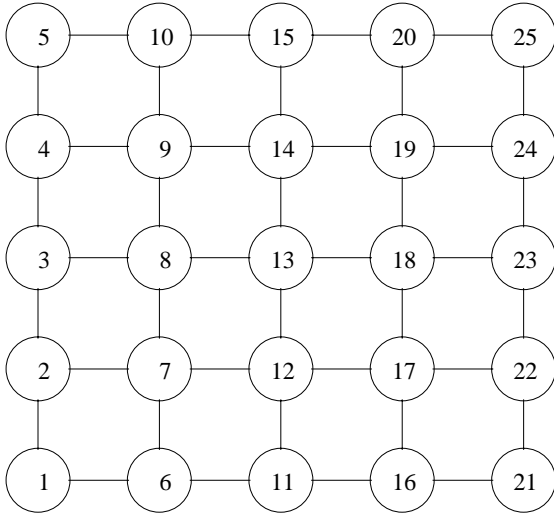

Fig. 6. Simulated Mesh Topology (5 X 5)

In our simulations, we experimented with TCP connections that traverse different number of hops. Note that throughput of a TCP connection decreases quite rapidly when the number of wireless hops is increased from 1 to 4. For future reference, the throughput of a single TCP connection using the 802.11 protocol, as a function of the number of hops, is as follows: one hop 1383.4 Kbps, two hops 687 Kbps, three hops 412.5 Kbps and four hops 274.8 Kbps.

The first scenario considered in our evaluation consists of two single-hop TCP connections, connection numbered 1 from node 6 to node 11 and connection numbered 2 from node 16 to node 21 (this scenario is similar to that in Figure 2). Table I presents the results for the first scenario.

TABLE I

Connections	IEEE 802.11	Scheme 1
No.1 (6 → 11)	1130.42	771.27
No.2 (16 → 21)	214.57	1040.21
Total Throughput (Kbps)	1344.99	1811.48

In Table I (and other tables in this paper), a row labeled No. i provides throughput measurements for connection numbered i . The row labeled Total Throughput lists the sum of throughput of all TCP connections considered in the scenario. Different columns of the table correspond to different MAC schemes.

In Table I, the total throughput of D-MAC Scheme 1 is higher than the IEEE 802.11 MAC scheme. This is because, with D-MAC Scheme 1, simultaneous transmissions on the two TCP connections are allowed by using directional RTS packet. On the other hand, when using the 802.11 scheme, the two connections cannot transmit packets at the same time.

Another interesting issue in the above scenario is *fairness*. As can be seen in Table I, the behavior of IEEE 802.11 protocol is unfair in that throughput of connection number 2 is much lower than that achieved with connection number 1. The fairness using scheme 1 is much better than 802.11.

Note that the aggregate throughput of the two connections above using IEEE 802.11 is comparable to that of a single TCP connection using IEEE 802.11 – essentially, in this case, when 2 connections are opened, they share the bandwidth that would have been otherwise available to a single connection.

TABLE II

Connections	IEEE 802.11	Scheme 1
No.3 (6 → 1)	653.64	1250.14
No.4 (11 → 16)	634.58	1251.64
Total Throughput (Kbps)	1288.22	2501.79

The second scenario considered here also consists of two single-hop TCP connections, connection numbered 3 from node 6 to node 1 and connection numbered 4 from node 11 to node 16 (similar to Figure 3). The simulation results from the second scenario are reported in Table II. The total throughput using the 802.11 protocol in scenario 2 is comparable with scenario 1. However, the performance of the D-MAC scheme 1 in Table II is better than in scenario 1. This is because, in scenario 2, there is a smaller probability of control packet collisions when using the D-MAC scheme 1, as compared to in scenario 1. For instance in scenario 1, imagine that node 6 transmits a DRTS packet to node 11 while node 16 has already started a packet transfer to node 21. Because node 11 would not have received node 16's DRTS packet, it may send an OCTS packet in reply to the DRTS from node 6. This OCTS packet can interfere with the reception of ACK from 21 to 16, causing degradation of the performance. Despite this possibility of collision of OCTS and ACK control packets, Table I also shows that aggregate throughput with D-MAC scheme 1 is better than the 802.11 – the reason is that the performance benefit of being able to perform multiple transfers in vicinity of each other (which may be disallowed in 802.11), outweighs the potential performance loss due to collision of control packets. In scenario 2, such collisions cannot occur (since the direction of data transfer is different from scenario 1) – therefore, observe that scheme 1 yields throughput twice that of 802.11. Scenario 2 represents the best case for the use of directional antennas.

TABLE III

Connections	IEEE 802.11	Scheme 1	Scheme 2
No.5 (1 → 21)	179.66	207.41	210.20
No.6 (1 → 5)	179.46	209.53	216.53
Total Throughput	359.12	416.94	426.73

Now we consider scenario 3, in which TCP connection number 5 is established from node 1 to node 21, and connection number 6 from node 1 to node 5 in Figure 6. Thus, connection 5 traverses a row in the 5x5 mesh, and connection 6 traverses a column. Both paths consist of four hops. Table III presents the throughput measurements. Observe that, in this case, all three MAC schemes are quite fair. From the performance point of view, D-MAC schemes 1 and 2 both achieve significant improvement over 802.11, with scheme 2 achieving

the largest throughput. Recall that, with D-MAC scheme 2, the probability of control packet collisions decreases. Therefore, scheme 2 sometimes (not always, as seen later) achieves higher throughput than scheme 1.

TABLE IV

Connections	IEEE 802.11	Scheme 1	Scheme 2
No.7 (1 → 21)	157.50	146.73	165.89
No.8 (2 → 22)	89.90	85.31	81.30
No.9 (3 → 23)	22.00	91.39	105.03
No.10 (4 → 24)	89.29	82.30	82.83
No.11 (5 → 25)	157.94	153.30	163.37
Total Throughput	516.63	559.03	598.42

Scenario 4 consists of 5 TCP connections, each connection traverses one row of the 5x5 mesh in Figure 6. Thus, the 5 TCP connections are from node 1 to 21, node 2 to 22, node 3 to 23, node 4 to 24 and node 5 to 25. These connections will be referred to as connections numbered 7 through 11, respectively.

Table IV presents the throughput measurements for scenario 4. For all three schemes, the “border” connections numbered 7 and 11 show much higher throughput than other interior connections (connections 8, 9 and 10). This is because the border connections share wireless medium with only one other connection, whereas the interior connections share the medium with two other connections. Similar to the case of two connections in Table III, both directional MAC schemes have better total throughput than IEEE 802.11, with D-MAC scheme 2 achieving the highest total throughput. However, the percentage improvement in scenario 4 is not as large as scenario 3, because even with directional antennas transfers on two adjacent TCP connections may interfere. However, observe that the D-MAC schemes are somewhat fairer (particularly, to connection 9) than 802.11 in this scenario.

TABLE V

Connections	IEEE 802.11	Scheme 1	Scheme 2
No.12 (1 → 21)	76.38	112.57	87.00
No.13 (2 → 22)	23.93	40.26	25.27
No.14 (3 → 23)	7.08	36.03	23.66
No.15 (4 → 24)	36.91	32.80	37.50
No.16 (5 → 25)	128.75	98.10	120.23
No.17 (1 → 5)	74.67	117.08	85.96
No.18 (6 → 10)	21.60	42.17	28.98
No.19 (11 → 15)	6.80	40.46	26.73
No.20 (16 → 20)	36.48	36.87	35.76
No.21 (21 → 25)	125.36	101.27	122.11
Total Throughput	537.96	657.61	593.20

Next, in scenario 5, we increase the number of TCP connections to 10, with 5 connections traversing the 5 rows, and 5 connections traversing the 5 columns in Figure 6. Each of these connections traverses four hops. Table V presents the throughput measurements for scenario 5.

In this case, although both D-MAC schemes achieve significantly better throughput than 802.11, D-MAC scheme 1 performs better than scheme 2.

As discussed earlier, D-MAC scheme 2 can reduce the probability of collision of control packets. This factor usually contributes to an increase in aggregate throughput. However, ORTS packets in scheme 2 also reduce the possibilities for simultaneous transmission by neighboring nodes (below we present an example to illustrate this). Thus, the network performance improvement by scheme 2 (compared to scheme 1) depends on whether the benefit of reducing control packet collision outweighs the decrease in throughput resulting from reduced possibilities for simultaneous packet transmissions. Thus, there exists a trade-off between probability of collisions of control packets and disallowed simultaneous transmissions, when D-MAC schemes 1 and 2 are compared.

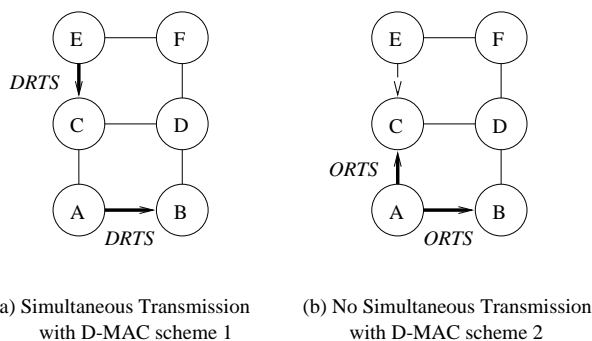

Fig. 7. Difference between D-MAC schemes 1 and 2

To illustrate the above issue, consider the network consisting of 6 nodes in Figure 7. Assume that 2 TCP connections are established – one from node E to C and another from A to B. In Figure 7(a), when D-MAC scheme 1 is used, node E can transmit to node C, while node A is transmitting to node B. However, with D-MAC scheme 2, this may not always be possible – when node E sends an DRTS to node C, node C will not send ORTS to E, if it has heard an ORTS for an on-going transfer from node A (See Figure 7(b)). Due to scenarios similar to the above, we believe that, D-MAC scheme 1 allows more simultaneous transmissions when the number of connections are increased both horizontally and vertically, compared to D-MAC scheme 2. This results in larger aggregate throughput for D-MAC scheme 1.

To verify this intuition, we now consider similar simulations with 3x3 and 6x6 topologies. We measure the aggregate throughput for 6 TCP connections in 3x3 mesh topology (one connection along each row and column) and for 12 TCP connections in 6x6 topology (again, one connection along each row and column), to compare with the results for the 10 connections in 5x5 topology. Table VI presents the aggregate throughput achieved by the TCP connections using the three MAC schemes. Observe that D-MAC scheme 2 has the largest throughput in the case of 3x3 topology, whereas D-MAC scheme 1 has the largest throughput with 6x6 topology. In summary, we conclude that the effects of concurrent transmission is inversely proportional to the complexity of TCP connection “topology.”

TABLE VI

Topology	IEEE 802.11	Scheme 1	Scheme 2
3x3 (6 conn.)	653.42	901.22	1165.32
5x5 (10 conn.)	537.96	657.61	593.20
6x6 (12 conn.)	495.86	635.60	576.85

VI. ADDITIONAL DISCUSSIONS

A. Optimization: Directional Wait-To-Send (DWTS) packet

We showed above that using directional RTS packets (DRTS) can potentially improve performance of wireless ad hoc networks. Let us consider another scenario for using DRTS packets. In Figure 8, nodes B and C communicate with each other for some duration of time, similar to Figure 2. However, unlike Figure 2, where node D has data packets for node E during that period of time, now node E wishes to transmit to node D. When using the first directional MAC mechanism, node E sends a DRTS in the direction of node D and expects an OCTS packet to be returned from D. Node D may know the fact that node C is receiving data packets from node B so its OCTS reply for node E can disturb node C's data reception from node B. Therefore, D will be silent despite a DRTS from node E until the proposed transmission between B and C is done. This can cause unnecessary retransmission of directional RTS from E to D (See Figure 8). This situation would happen in the current IEEE 802.11 protocol as well.

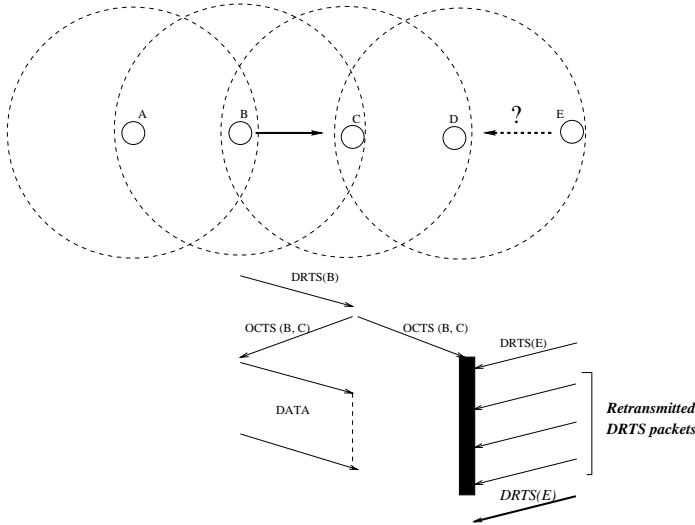

Fig. 8. Useless retransmission of RTS packets

One solution to prevent this situation is to introduce a short control packet, *directional Wait-To-Send (DWTS)*. DWTS messages can be used for preventing useless retransmission of RTS packets by telling how much time to wait before retrying the RTS packets. Thus, a DWTS packet contains a duration field that indicates the period a node must wait for transmission. When a node receives a directional RTS (DRTS) packet from its neighbor while it is aware of another on-going transmission, it replies with a DWTS packet to the neighbor that sent the DRTS

packet.

Figure 9 illustrates this mechanism. In the figure, a DRTS packet from nodes E to D follows an omnidirectional CTS (OCTS) packet from node C. Upon receiving the DRTS, node D returns a DWTS packet back to node E because D cannot reply with an OCTS packet for node E at this time. Using directional WTS packets can avoid useless retransmission of DRTS packet by node E until the time specified in the duration field of DWTS packet has elapsed. When E sends the next DRTS (after waiting appropriate duration), node D replies with an OCTS (See Figure 9). The main idea of using DWTS packet is to let node E know about how much to wait before retrying the DRTS packet.

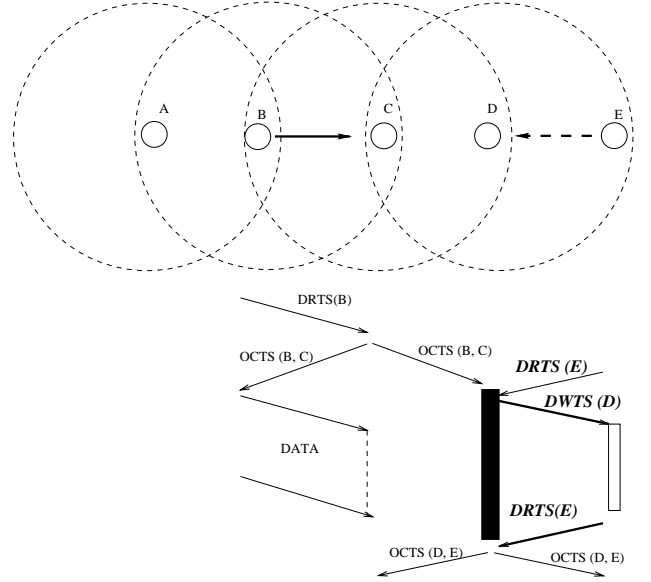

Fig. 9. Example of using DWTS packets: The figure shows that unnecessary retransmissions of DRTS can be prevented by using DWTS packet

B. Conflict-Free ACK

In the current IEEE 802.11 MAC protocol standard, *immediate link layer acknowledgements*⁴ are employed to determine if the data packet was successfully received. Thus, RTS-CTS-DATA-ACK exchange mechanism is used to enhance reliability of data transmission. Note that, in our proposed directional MAC schemes, returning the ACK packet immediately after the DATA is also assumed.

In 802.11, ACK packet collisions are minimized since the transmission range of both a transmitter and a receiver is reserved. However, in our D-MAC schemes, there is no guarantee of collision-free ACK packet reception even though scheme 2 reduces the probability of packet collisions by using ORTS packets. To remedy this problem of no ACK collision guarantee, we present some approaches below, which would be evaluated in future work⁵.

a) Use Two Channels

To guarantee no conflicts of ACK packets, the single common channel may be split into two separate channels: one for DATA

⁴Here, an ACK is treated as a control packet sent by a MAC layer. Therefore, no RTS is sent for the ACK.

⁵More discussions about guaranteeing no conflict of ACK packets can be found in [9].

and ACK packet transmission, and the other for RTS and CTS packet transmission. MAC-level acknowledgement requires the receiving node of data packets to respond with an ACK immediately, without exchanging RTS/CTS control packets. This implies that ACK packets are generated by the MAC layer and they are sent on the data channel which has been used for the corresponding DATA reception. Since ACK packets are transmitted on a different channel than other control packets (RTS/CTS), conflict-free transmission for the ACK can be guaranteed.

b) Exchange Another RTS/CTS for ACK packets

Another possible solution is to perform *RTS/CTS exchange for the ACK itself*. A single common channel is assumed here. The basic idea is that an ACK packet is considered as another data packet requiring a successful RTS/CTS exchange. Unlike immediate MAC-level acknowledgement mechanisms described above, ACK packets are generated by an upper layer such as logical link control (LLC). To send the ACK successfully, another successful exchange of RTS and CTS packets is required. Of course, this additional RTS/CTS exchange mechanism would decrease bandwidth efficiency due to overhead. Thus, there exists a trade-off between reliability of data transmission and the control packet overhead.

C. Location Information

The assumption in the above discussion is that a node knows its own location and neighbors' location accurately – this information is necessary to determine which directional antenna to use either to send DRTS or DATA. When the nodes are mobile, it is hard to know the precise location of a node at all times. A mobile node may inform its location to its neighbor periodically using beacons. Also, the location information could be included in other messages (such as RTS and CTS). However, due to node mobility, the location information can become stale. Since we suggest using directional antennas for DRTS and/or DATA, it is useful to consider how the protocol should be modified when location information is not known accurately.

When a node X wishes to send data to node Y, it may send DRTS or ORTS, using our protocols. Of course, for sending ORTS, node X need not know Y's location. However, to send DRTS, X needs to know the location. If X does not have any location information for Y, then the DRTS may be replaced by ORTS, without loss of correctness. On the other hand, if node X does know, potentially out-dated, location of node Y, then X can transmit the DRTS in the appropriate direction. A reply to the first DRTS may not be received, due to various reasons, such as transmission errors or because the out-dated location information resulted in the use of a directional antenna that does not cover the current location of node Y. To deal with causes such as errors, node X may retransmit the DRTS after a suitable back-off interval. However, to recover from out-dated location information, an ORTS must be transmitted. Thus, in general, node X may retransmit the DRTS upto a specified threshold, and then default to using an ORTS. It is important to note that using an ORTS instead of a DRTS does not affect correctness of the MAC protocol.

When sending the data as well, node X uses a directional antenna. Since an RTS/CTS exchange precedes data transmission, and since location information of node Y can be included in

the CTS message, node X has accurate location information. Node X can use this information to choose the appropriate directional antennas. There is always a (small) probability that node Y moves out of scope of the chosen directional antenna *during* the data transfer. This may result in the loss of the data packet, and may be handled similar to a loss due to transmission errors.

VII. CONCLUSION

The current MAC protocols using omnidirectional Request-to-Send (RTS) and Clear-to-Send (CTS) can waste wireless bandwidth by reserving the wireless medium over a large area. To improve bandwidth efficiency of the previous MAC protocols, we propose a new approach, named "*Directional MAC*" (D-MAC), utilizing the directional transmission capability of a directional antenna. We considered several possible cases and proposed two different schemes: D-MAC scheme 1 for using only directional RTS (DRTS) packets, and D-MAC scheme 2 for using both directional RTS and omnidirectional RTS (ORTS) packets. We also discussed an optimization using directional Wait-to-Send (DWTS) packets to prevent unnecessary retransmissions of RTS packets. By simulation studies, we compared our directional MAC mechanisms to the IEEE 802.11 protocol. In summary, our directional MAC protocols can improve performance by allowing simultaneous transmissions that are not allowed in the current MAC protocols.

ACKNOWLEDGMENT

We thank the referees for their helpful comments.

APPENDIX

The pseudo-code for directional MAC scheme 1 is presented below. This presentation assumes familiarity with IEEE 802.11 MAC and the associated jargon and abbreviations. There are two timers in 802.11: *defer timer* and *backoff timer*. A defer timer is used to wait for the appropriate interframe space (IFS) when the transmission medium is idle. Note that three IFS intervals are specified in the standard: short IFS (SIFS), point coordination function IFS (PIFS), and distributed coordination function IFS (DIFS). A backoff timer is used to wait for the duration of a contention window (CW) as per 802.11. NAV stands for network allocation vector and it indicates the amount of time that must elapse until the current transmission session is complete. The term "selected antenna" in the pseudo-code below refers to the antenna to be used for the desired directional transmission.

```

Procedure MAIN()
Begin
  Set each of the antenna MAC states as IDLE
  Initialize NAV for the directional antennas

  if (Packet p detected) then Call procedure RECV(p)
  else
    if (a timeout occurred) then
      Call the appropriate handler
  End
End

Procedure RECV (p)
Begin
  if (p is an outgoing packet) then
    Call procedure SEND(p) ;
  else
    if (MAC reception state is IDLE) then
      Begin
        set the MAC state as MAC_RECV;
        call Receive_Packet(p)
      End
    End
  End
End

```



```

Procedure SEND(p)
Begin
  if (Selected Antenna is idle) then
    Begin
      Defer for a DIFS period before transmitting;
      if already deferring, no need to reset
      the Defer timer.
      /* After deferring, XMIT() will be called */
    End
  else
    Start the backoff timer.
    /* After the timer expires, XMIT() called */
  End
End

Procedure XMIT(Pkt)
Begin
  if (Pkt is of Control type - except for RTS) then
    Begin
      Case (Subtype of the Pkt)
      Begin
        CTS:
          if (All the antennas are not idle) then
            discard(pkt);
            return ;

          set MAC transmission state as MAC_CTS.
          set all antennas as busy.
          set the timeout according to the 802.11 Spec.
          break;

        ACK:
          set the MAC transmission state as MAC_ACK;
          set the selected antenna as Busy;
          set the timeout according to the 802.11 Spec.
          break;
      End /* case */
      TRANSMIT(pkt); /* transmit a packet to a channel */
    End

  else if (Pkt is of RTS type) then
    Begin
      /* can send RTS only when the specified */
      /* antenna is idle */
      Get the Selected Antenna; /* the antenna that RTS
      will be transmitted */
      if (Selected Antenna is not idle) then
        Back off the contention window;
        Set the Backoff timer
        return ;

        set the MAC transmission state as MAC_RTS.
        set the timeout as specified in 802.11 Spec.
        TRANSMIT(pkt);
      End
    else if (Pkt is of DATA) then
      Begin
        if (Selected Antenna is not idle) then
          back off the contention window;
          set the backoff timer.
          return ;

          set the transmission state as MAC_SEND;
          set the selected antenna as busy;
          set the timeout appropriately.
          TRANSMIT(pkt)
        End
      End
    End

Procedure Receive_Packet()
Begin
  if (the Packet is an RTS) then
    Begin
      if (the RTS is for this node) then
        send CTS packet. /* omnidirection */
      else
        update the NAV for this antenna
        and set it as BUSY
      End
    else if (the Packet is a CTS) then
      Begin
        if (the CTS for this node &&
        MAC state is MAC_RTS) then
          send Data packet. /* selected direction */
        else
          update the NAV for this antenna
          and set it as BUSY
        End
      else if (the Packet is Data) then
        Begin
          if (the packet is for this node) then
            send ACK packet into selected direction; /*
            pass the packet up to the link-layer.
          else
            discard the Packet
          End
        else if (the packet is ACK) then
          Begin
            reset the contention window;
            start the backoff timer;
            set MAC states as IDLE;
            resume transmission of the next packet.
          End
        End
      End
    End
  End

```

REFERENCES

- [1] "Iowa State University GPS page." Web site at <http://www.cnde.iastate.edu/gps.html>.
- [2] "Wireless LAN medium access control (MAC) and physical layer (PHY) specifications," 1997. Draft Standard IEEE 802.11, P802.11/D1: The editors of IEEE 802.11.

- [3] J. Broch, D. A. Maltz, D. B. Johnson, Y.-C. Hu, and J. Jetcheva, "A performance comparison of multi-hop wireless ad hoc network routing protocols," in *ACM/IEEE Int. Conf. on Mobile Computing and Networking (MobiCom '98)*, Oct. 1998.
- [4] H. Chhaya, "Performance evaluation of the IEEE 802.11 MAC protocol for wireless LANs," Master's thesis, Illinois Institute of Technology, Chicago, 1996.
- [5] S. Corson and J. Macker, "Mobile ad hoc networking (MANET): Routing protocol performance issues and evaluation considerations (Internet-Draft)," *Mobile Ad-hoc Network (MANET) Working Group, IETF*, Oct. 1998.
- [6] K. Fall and K. Varadhan, "ns Notes and Documentation," August 1998. Web site at <http://www-mash.cs.berkeley.edu/ns/>.
- [7] M. Horneffer and D. Plassmann, "Directed antennas in the mobile broadband system," in *Proc. of IEEE INFOCOM '96*, pp. 704-712, 1996.
- [8] P. Karn, "MACA - A new channel access method for packet radio," in *Proc. of ARRL/CRRL Amateur Radio 9th Computer Networking Conference*, September 1990.
- [9] Y.-B. Ko and N. H. Vaidya, "Medium access control protocols using directional antennas in ad hoc networks," Tech. Rep. 99-010, CS Dept., Texas A&M University, May 1999.
- [10] Y.-B. Ko and N. H. Vaidya, "Location-aided routing (LAR) in mobile ad hoc networks," in *ACM/IEEE the 4th Annual Intl. Conference on Mobile Computing and Networking (MobiCom '98)*, October 1998.
- [11] C. Lau and C. Leung, "A slotted ALOHA packet radio networks with multiple antennas and receivers," *IEEE Transactions on vehicular technology*, vol. 39, no. 3, pp. 218-226, 1990.
- [12] G. T. Okamoto, *Smart Antenna Systems and Wireless LANs*. Kluwer Academic Publishers, 1998.
- [13] N. Pronios, "Performance considerations for slotted spread-spectrum random access networks with directional antennas," in *Proc. of IEEE GLOBECOM '89*, Nov. 1989.
- [14] C. Sakr and T. Todd, "Carrier-sense protocols for packet-switched smart antenna basestation," in *Proc. of ICNP '97, 1997*.
- [15] F. Shad, T. Todd, V. Kezys, and J. Litva, "Indoor SDMA capacity using a smart antenna basestation," in *Proc. of IEEE ICUPC '97*, pp. 868-872, 1997.
- [16] V. Bhargavan, A. Demers, S. Shenker, and L. Zhang, "MACAW - A media access protocol for wireless LANs," in *Proc. of ACM SIGCOMM '94*, September 1994.
- [17] J. Ward and R. Compton, "Improving the performance of slotted ALOHA packet radio network with an adaptive array," *IEEE Transactions on Communications*, vol. 40, pp. 292-300, Feb. 1992.
- [18] J. Ward and R. Compton, "High throughput slotted ALOHA packet radio networks with adaptive arrays," *IEEE Transactions on Communications*, vol. 41, pp. 460-470, Mar. 1993.
- [19] T.-S. Yum and K.-W. Hung, "Design algorithms for multihop packet radio networks with multiple directional antennas stations," *IEEE Transactions on communications*, vol. 40, no. 11, pp. 1716-1724, 1992.
- [20] J. Zander, "Slotted ALOHA multihop packet radio networks with directional antennas," *Electronics Letters*, vol. 26, no. 25, 1990.